



## PKT / PKS / PKH SERIES - CAM SWITCHES

- Complete range of cam switches for control, instrumentation and motor starting applications.
- Available for currents from 6 A to 200 A.
- Quick and easy installation.
- Compact size with many switching programs.
- Multi pole design.
- Long distance visibility.
- Touch-proof terminals with IP20 protection.

TYPES:

**PKT1, PKS1, PKH1** - CHANGEOVER

**PKT2, PKS2, PKH2** - MULTI-STEP

**PKT3, PKS3, PKH3** - ISOLATOR

**PKT4** - SELECTOR

### APPLICATION EXAMPLES

Switching on the (emergency) power supply.

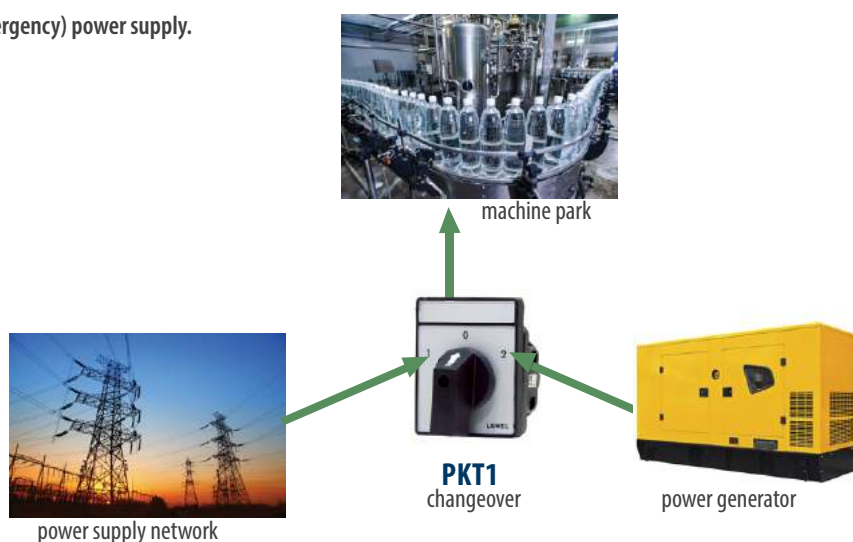

Measurement of phase and phase-to-phase voltage using only one voltmeter.

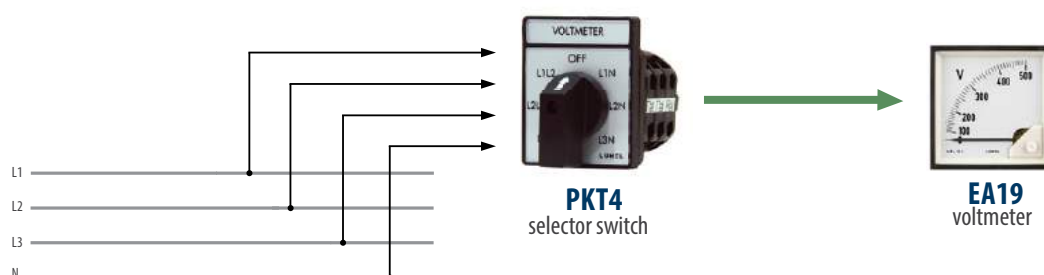

# PKT1 / PKT2 / PKT3 / PKT4

## - CAM SWITCHES

### EXTERNAL DIMENSIONS

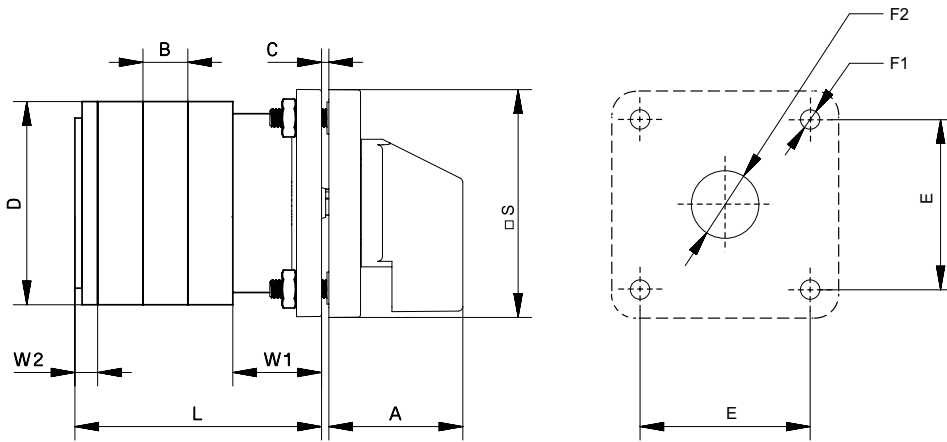

$L = \text{No. of Stages of Prog} \times B + W1 + W2$

Drilling plane

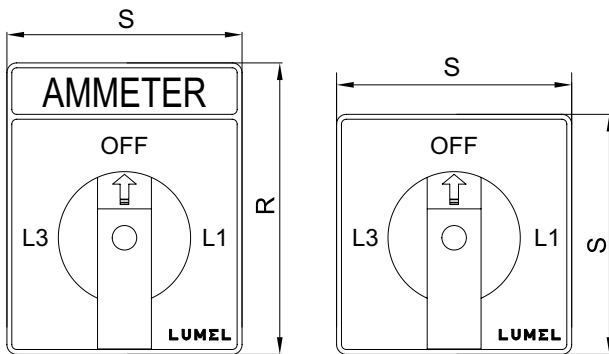

Type	A	B	C <sub>(max)</sub>	D	E	F1	F2	R	S	W1	W2
6 A	29 mm	9.7 mm	4 mm	32 mm	36 mm	4 mm	8 mm	48 mm	48 mm	13 mm	7 mm
10 A	29 mm	9.5 mm	4 mm	43 mm	36 mm	4 mm	7 mm	60 mm	48 mm	19 mm	5 mm
16 A	29 mm	9.5 mm	4 mm	43 mm	36 mm	4 mm	7 mm	60 mm	48 mm	19 mm	5 mm
20 A	29 mm	9.5 mm	4 mm	43 mm	36 mm	4 mm	7 mm	60 mm	48 mm	19 mm	5 mm
25 A	34 mm	14.3 mm	4 mm	53 mm	48 mm	4 mm	12 mm	64 mm	64 mm	24 mm	6.2 mm
32 A	34 mm	14.3 mm	4 mm	53 mm	48 mm	4 mm	12 mm	64 mm	64 mm	24 mm	6.2 mm
40 A	34 mm	14.3 mm	4 mm	53 mm	48 mm	4 mm	12 mm	64 mm	64 mm	24 mm	6.2 mm
63 A	34 mm	14.3 mm	4 mm	53 mm	48 mm	4 mm	12 mm	64 mm	64 mm	24 mm	6.2 mm
100 A	49 mm	29 mm	4 mm	88 mm	68 mm	5.5 mm	18 mm	88 mm	88 mm	27 mm	7 mm
200 A	49 mm	29 mm	4 mm	88 mm	68 mm	5.5 mm	18 mm	88 mm	88 mm	27 mm	7 mm

### INSTALLATION

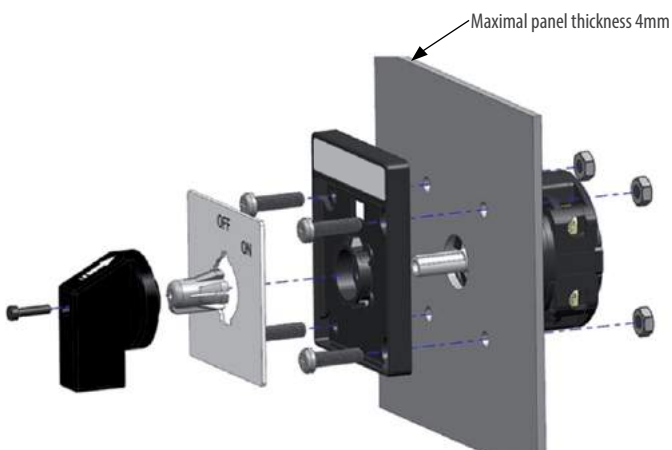

### AC DUTY RATINGS

Class	Application
AC-1	Non-Inductive or slightly inductive loads ( $\cos\phi \geq 0,95$ ); Resistance furnaces
AC-3	Squirrel-cage motors: starting switching off motors during running
AC-15	Control of AC electromagnetic loads
AC-21-A	Switching of resistive loads, including moderate overloads (frequent switching)
AC-23-A	Switching of motor loads or other highly inductive loads (frequent switching)

# PKT1 / PKT2 / PKT3 / PKT4

## - CAM SWITCHES

### TECHNICAL DATA

PARAMETERS		UNIT	6 A	10 A	16 A	20 A	25 A	32 A	40 A	63 A	100 A	200 A
Rated operational voltage (Ue)		V	440	440	690	690	690	690	690	690	690	690
Rated insulation voltage (Ui)		V	440	440	690	690	690	690	690	690	690	690
Rated uninterupted current (Ith)		A	8	12	20	25	25	32	40	63	100	200
Rated short time withstand current (Icw)		A	72	120	192*	240*	300	384	480	756	1200	2400
Rated impulse withstand voltage (Uimp)		kV	4	4	4	4	6	6	6	6	6	6
Rated Fuse short circuit current		kA	3	3	5	5	10	10	10	10	15	25
Fuse size (Type gG/ gM)		A	6	10	16	20	25	32	50	63	100	200
The power of the receiver in terms of use												
AC23A 3 phase	220-240V	kW	1.1	1.8	3	3.7	4.7	5.5	7.5	11	22	22
	380-440V	kW	1.8	3	5.5	7.5	7.5	11	15	18.5	37	37
	500V	kW	-	-	5.5	7.5	11	15	18.5	22	45	45
	660-690V	kW	-	-	5.5	7.5	11	15	18.5	22	45	45
AC23A 1 phase	110V	kW	0.25	0.37	0.55	0.75	1.5	2.2	2.2	3	-	-
	220-240V	kW	0.5	0.75	1.5	2.2	3	3.7	5.5	7.5	-	-
	380-440V	kW	0.75	1.1	2.2	3.7	5.5	7.5	7.5	11	-	-
AC3 3 phase	220-240V	kW	1.1	1.5	3	3	4.7	5.5	7.5	11	22	22
	380-440V	kW	1.8	2.2	5.5	5.5	7.5	11	15	18.5	37	37
	500V	kW	-	-	5.5	5.5	11	15	18.5	22	45	45
	600-690V	kW	-	-	5.5	5.5	11	15	18.5	22	45	45
AC3 1 phase	110V	kW	0.25	0.3	0.55	0.6	1.5	2.2	2.2	3	-	-
	220-240V	kW	0.5	0.55	1.5	2.2	3	3.7	5.5	7.5	-	-
	380-440V	kW	0.75	0.75	2.5	3	5.5	7.5	7.5	11	-	-
	AC21A/AC1	A	6	10	16	20	25	32	40	63	100	200
AC15	220-240V	A	2	2.5	5	5	8	14	16	16	20	-
	380-440V	A	1	1.5	4	4	5	6	7	7	10	-
Terminal cross-section												
Single / Multiple	Min	mm <sup>2</sup>	0.7	0.7	1.5	1.5	2.5	2.5	4	4	10	10
	Max	mm <sup>2</sup>	1.5	1.5	4	4	4	6	10	16	35	70
Fine strand with sleeve	Min	mm <sup>2</sup>	0.7	0.7	1	1	1.5	1.5	2.5	2.5	10	10
	Max	mm <sup>2</sup>	1.5	1.5	2.5	2.5	4	4	6	16	35	50
Terminal screw		metric	M3	M3	M3	M3	M4	M4	M4	M4	M10	M10
Terminal tightening torque		Nm	0.8	0.8	0.8	0.8	1.2	1.2	1.2	1.2	2.5	2.5

\* Rated short time withstand current (0.5s- current)

### RATED OPERATING CONDITIONS

Frequency	50/60 Hz	
Operating temperature	-25°C...60°C	
Storage temperature	-40°C...80°C	
Installation category	III	
Altitude a.s.l.	2000 m	
Protection grade	IP50 from frontal side	IP20 from terminal side
Standards	IEC 60947-1, IEC 60947-3, IEC 60947-5	

### SWITCH LIFE

Mechanical Life	100 000 operations at 300 cycles/hr	
Electrical Life	10 000 operations at 100% rated duty at 120 cycles/hr	
Contacts	double break	type AgNi
	double break	type AgCdO

# PKT1/ PKS1/ PKH1 SERIES

## - CHANGEOVERS

### WIRING DIAGRAMS AND CODING

### CHANGEOVERS PKT1, PKS1, PKH1

Ordering code PKT1- **60L** 02OF \_00  
 PKS1- **60L** 02OF \_00  
 PKH1- **60L** 02OF \_00

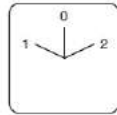

Changeover PKT1- PKS1- PKH1-		60L	02OF			00
<b>Rated current:</b>						
6 A		A				
10 A	PKT1	B				
16 A		C				
25 A		D				
32 A	PKS1	E				
40 A		F				
63 A		G				
100 A	PKH1	H				
200 A		I				
<b>Pole:</b>						
1 pole			1			
2 poles			2			
....			...			
6 poles			6			
<b>Front plate colour:</b>						
silver background and black knob						A
yellow background and red knob						Y
<b>Acceptance tests:</b>						
without additional quality requirements						0
with an extra quality inspection certificate						1

#### ITEMS AVAILABLE FROM OUR STOCK:

##### PKT1-C60L1020FA000

- Changeover 16A, angle 60°, rotation angle <360°, 1 pole, 2 ways, with OFF, rectangular knob, silver background, black knob

##### PKT1-C60L1020FY000

- Changeover 16A, angle 60°, rotation angle <360°, 1 pole, 2 ways, with OFF, rectangular knob, yellow background, red knob

Description	PKT1			PKS1			PKH1		
	6A	10A	16A	25A	32A	40A	63A	100A	200A
	<b>Stage number</b>								
1-polar 2-way + OFF	1	1	1	1	1	1	1	1	1
2-polar 2-way + OFF	2	2	2	2	2	2	2	2	2
3-polar 2-way + OFF	3	3	3	3	3	3	3	3	3
4-polar 2-way + OFF	4	4	4	4	4	4	4	4	4
5-polar 2-way + OFF	5	5	5	5	5	5	5	5	5
6-polar 2-way + OFF	6	6	6	6	6	6	6	6	6

OUTPUT SIDE	1A	2A	1B	2B	1C	2C	1D	2D	1E	2E	1F	2F
INPUT SIDE	LA	LA	LB	LB	LC	LC	LD	LD	LE	LE	LF	LF
POLES	1		2		3		4		5		6	
0												
1	X		X		X		X		X		X	
2		X		X		X		X		X		X

Ordering code PKT1- **90T** 02OF \_00  
 PKS1- **90T** 02OF \_00  
 PKH1- **90T** 02OF \_00

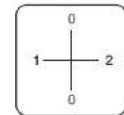

Changeover PKT1- PKS1- PKH1-		90T	02OF			00
<b>Rated current:</b>						
6 A		A				
10 A	PKT1	B				
16 A		C				
25 A		D				
32 A	PKS1	E				
40 A		F				
63 A		G				
100 A	PKH1	H				
200 A		I				
<b>Pole:</b>						
1 pole			1			
2 poles			2			
....			...			
6 poles			6			
<b>Front plate colour:</b>						
silver background and black knob						A
yellow background and red knob						Y
<b>Acceptance tests:</b>						
without additional quality requirements						0
with an extra quality inspection certificate						1

Description	PKT1			PKS1			PKH1		
	6A	10A	16A	25A	32A	40A	63A	100A	200A
	<b>Stage number</b>								
1-polar 2-way + OFF	1	1	1	1	1	1	1	1	1
2-polar 2-way + OFF	2	2	2	2	2	2	2	2	2
3-polar 2-way + OFF	3	3	3	3	3	3	3	3	3
4-polar 2-way + OFF	4	4	4	4	4	4	4	4	4
5-polar 2-way + OFF	5	5	5	5	5	5	5	5	5
6-polar 2-way + OFF	6	6	6	6	6	6	6	6	6

OUTPUT SIDE	1A	2A	1B	2B	1C	2C	1D	2D	1E	2E	1F	2F
INPUT SIDE	LA	LA	LB	LB	LC	LC	LD	LD	LE	LE	LF	LF
POLES	1		2		3		4		5		6	
0												
1	X		X		X		X		X		X	
2		X		X		X		X		X		X

# PKT1/ PKS1/ PKH1 SERIES

## - CHANGEOVERS

### WIRING DIAGRAMS AND CODING

### CHANGEOVERS PKT1, PKS1, PKH1

Ordering code PKT1- 90T 02WF \_ 00  
 PKS1- 90T 02WF \_ 00  
 PKH1- 90T 02WF \_ 00

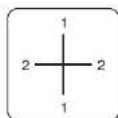

Changeover PKT1- PKS1- PKH1-		90T	02WF		00
<b>Rated current:</b>					
6 A	A				
10 A	PKT1	B			
16 A		C			
25 A		D			
32 A	PKS1	E			
40 A		F			
63 A		G			
100 A		H			
200 A	PKH1	I			
<b>Pole:</b>					
1 pole			1		
2 poles			2		
....			...		
6 poles			6		
<b>Front plate colour:</b>					
silver background and black knob				A	
yellow background and red knob				Y	
<b>Acceptance tests:</b>					
without additional quality requirements				0	
with an extra quality inspection certificate				1	

Ordering code PKT1- 90T 03OF \_ 00  
 PKS1- 90T 03OF \_ 00  
 PKH1- 90T 03OF \_ 00

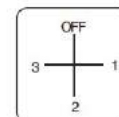

Changeover PKT1- PKS1- PKH1-		90T	03OF		00
<b>Rated current:</b>					
6 A	A				
10 A	PKT1	B			
16 A		C			
25 A		D			
32 A	PKS1	E			
40 A		F			
63 A		G			
100 A		H			
200 A	PKH1	I			
<b>Pole:</b>					
1 pole			1		
2 poles			2		
3 poles			3		
<b>Front plate colour:</b>					
silver background and black knob				A	
yellow background and red knob				Y	
<b>Acceptance tests:</b>					
without additional quality requirements				0	
with an extra quality inspection certificate				1	

Description	PKT1			PKS1				PKH1	
	6A	10A	16A	25A	32A	40A	63A	100A	200A
	Stage number								
1-polar 2-way	1	1	1	1	1	1	1	1	1
2-polar 2-way	2	2	2	2	2	2	2	2	2
3-polar 2-way	3	3	3	3	3	3	3	3	3
4-polar 2-way	4	4	4	4	4	4	4	4	4
5-polar 2-way	5	5	5	5	5	5	5	5	5
6-polar 2-way	6	6	6	6	6	6	6	6	6

Description	PKT1			PKS1				PKH1	
	6A	10A	16A	25A	32A	40A	63A	100A	200A
	Stage number								
1-polar 3-way + OFF	2	2	2	2	2	2	2	2	2
2-polar 3-way + OFF	3	3	3	3	3	3	3	3	3
3-polar 3-way + OFF	5	5	5	5	5	5	5	5	5

OUTPUT SIDE	1A	2A	1B	2B	1C	2C	1D	2D	1E	2E	1F	2F
INPUT SIDE	LA	LA	LB	LB	LC	LC	LD	LD	LE	LE	LF	LF
POLES	1		2		3		4		5		6	
0												
1	X		X		X		X		X		X	
2		X		X		X		X		X		X

OUTPUT SIDE	1A	2A	1B	3A	2B	2B	1C	2C	3C
INPUT SIDE	LA	LA	LB	LA	LB	LB	LC	LC	LC
POLES	1		2	1	2		3		3
OFF									
1	X		X				X		
2		X			X			X	
3				X		X			X

# PKT1/ PKS1/ PKH1 SERIES

## - CHANGEOVERS

### WIRING DIAGRAMS AND CODING

### CHANGEOVERS PKT1, PKS1, PKH1

#### CODING OF PKT1, PKS1, PKH1 SERIES

Changeover PKT1- PKS1- PKH1-		-	-	0	-	-	-	-	F	-	-	00
<b>Rated current:</b>												
6 A		A										
10 A	PKT1	B										
16 A		C										
25 A		D										
32 A	PKS1	E										
40 A		F										
63 A		G										
100 A		H										
200 A	PKH1	I										
<b>Angle:</b>												
60°		6										
90°		9										
		0										
<b>Rotation angle:</b>												
360°		T										
less than 360° *		L										
<b>Pole:</b>												
1 pole		1										
2 poles		2										
....		...										
6 poles		6										
<b>No. of ways:</b>												
2 ways		02										
3 ways		03										
<b>OFF way:</b>												
without OFF**		W										
with OFF		O										
		F										
<b>Front plate colour:</b>												
silver background and black knob		A										
yellow background and red knob		Y										
<b>Acceptance tests:</b>												
without additional quality requirements		0										
with an extra quality inspection certificate		1										
<b>Version:</b>												
standard		00										
custom-made***		XX										

\* - only for rotation angle 60°

\*\* - only for rotation angle 90°

\*\*\* - only after agreeing with the manufacturer

# PKT2, PKS2, PKH2 SERIES

## - MULTI-STEPS

### WIRING DIAGRAMS AND CODING

### MULTI-STEPS PKT2, PKS2, PKH2

Ordering code PKT2- 90T\_03OF\_00  
 PKS2- 90T\_03OF\_00  
 PKH2- 90T\_03OF\_00

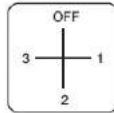

Ordering code PKT2- 60L\_04OF\_00  
 PKS2- 60L\_04OF\_00  
 PKH2- 60L\_04OF\_00

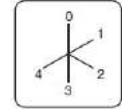

Multi-step PKT2- PKS2- PKH2-		90T	03	O	F			00
<b>Rated current:</b>								
6 A	A							
10 A	PKT2	B						
16 A		C						
25 A		D						
32 A	PKS2	E						
40 A		F						
63 A		G						
100 A	PKH2	H						
200 A		I						
<b>Pole:</b>								
1 pole			1					
2 poles			2					
3 poles			3					
4 poles			4					
<b>Front plate colour:</b>								
silver background and black knob								A
yellow background and red knob								Y
<b>Acceptance tests:</b>								
without additional quality requirements								0
with an extra quality inspection certificate								1

Multi-step PKT2- PKS2- PKH2-		60L	04	O	F			00
<b>Rated current:</b>								
6 A	A							
10 A	PKT2	B						
16 A		C						
25 A		D						
32 A	PKS2	E						
40 A		F						
63 A		G						
100 A	PKH2	H						
200 A		I						
<b>Pole:</b>								
1 pole			1					
2 poles			2					
3 poles			3					
<b>Front plate colour:</b>								
silver background and black knob								A
yellow background and red knob								Y
<b>Acceptance tests:</b>								
without additional quality requirements								0
with an extra quality inspection certificate								1

Description	PKT2			PKS2				PKH2	
	6A	10A	16A	25A	32A	40A	63A	100A	200A
	Stage number								
1-polar 3-way + OFF	2	2	2	2	2	2	2	2	2
2-polar 3-way + OFF	3	3	3	3	3	3	3	3	3
3-polar 3-way + OFF	5	5	5	5	5	5	5	5	5
4-polar 3-way + OFF	6	6	6	6	6	6	6	6	6

#### ITEMS AVAILABLE FROM OUR STOCK:

##### PKT2-C60L1040FA000

- Multi-step 16A, angle 60°, rotation angle <360°, 1 pole, 4 ways, with OFF, rectangular knob, silver background, black knob

##### PKT2-C60L1040FY000

- Multi-step 16A, angle 60°, rotation angle <360°, 1 pole, 4 ways, with OFF, rectangular knob, yellow background, red knob

Description	PKT2			PKS2				PKH2	
	6A	10A	16A	25A	32A	40A	63A	100A	200A
	Stage number								
1-polar 4-way + OFF	2	2	2	2	2	2	2	2	2
2-polar 4-way + OFF	4	4	4	4	4	4	4	4	4
3-polar 4-way + OFF	6	6	6	6	6	6	6	6	6

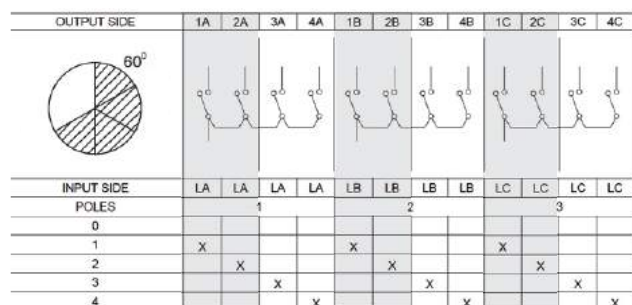
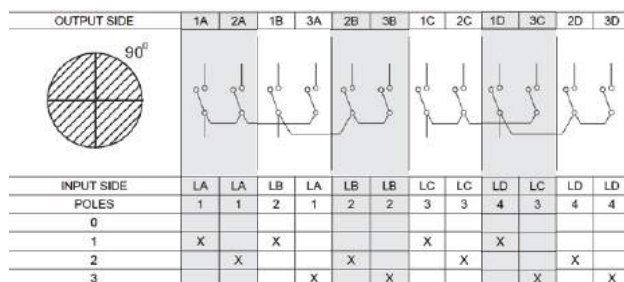

# PKT2, PKS2, PKH2 SERIES

## - MULTI-STEPS

### WIRING DIAGRAMS AND CODING

### MULTI-STEPS PKT2, PKS2, PKH2

Ordering code PKT2- 60T\_05OF\_00  
 PKS2- 60T\_05OF\_00  
 PKH2- 60T\_05OF\_00



Multi-step PKT2- PKS2- PKH2-		60T	05	O	F	00
<b>Rated current:</b>						
6 A		A				
10 A	PKT2	B				
16 A		C				
25 A		D				
32 A		E				
40 A	PKS2	F				
63 A		G				
100 A		H				
200 A	PKH2	I				
<b>Pole:</b>						
1 pole			1			
2 poles			2			
<b>Front plate colour:</b>						
silver background and black knob						A
yellow background and red knob						Y
<b>Acceptance tests:</b>						
without additional quality requirements						0
with an extra quality inspection certificate						1

Ordering code PKT2- 40L\_06OF\_00  
 PKS2- 40L\_06OF\_00

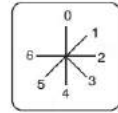

Multi-step PKT2- PKS2-		40L	06	O	F	00
<b>Rated current:</b>						
6 A		A				
10 A	PKT2	B				
16 A		C				
25 A		D				
32 A		E				
40 A	PKS2	F				
63 A		G				
<b>Pole:</b>						
1 pole						1
2 poles						2
<b>Front plate colour:</b>						
silver background and black knob						A
yellow background and red knob						Y
<b>Acceptance tests:</b>						
without additional quality requirements						0
with an extra quality inspection certificate						1

Description	PKT2			PKS2				PKH2	
	6A	10A	16A	25A	32A	40A	63A	100A	200A
	Stage number								
1-polar 5-way + OFF	3	3	3	3	3	3	3	3	3
2-polar 5-way + OFF	5	5	5	5	5	5	5	5	5

Description	PKT2			PKS2			
	6A	10A	16A	25A	32A	40A	63A
	Stage number						
1-polar 6-way + OFF	3	3	3	3	3	3	3
2-polar 6-way + OFF	6	6	6	6	6	6	6

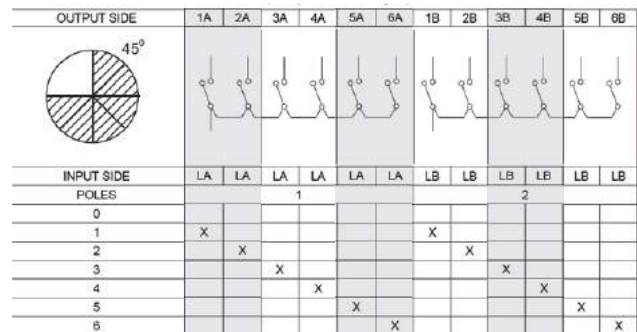
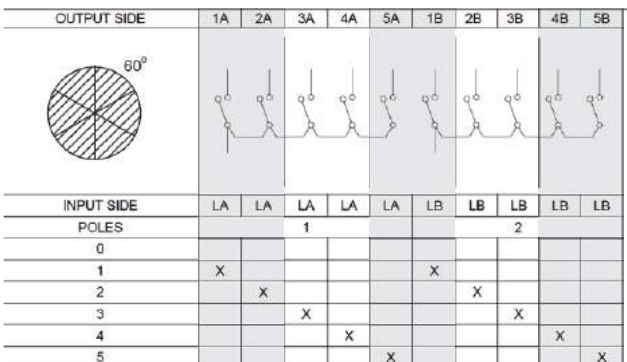



# PKT2, PKS2, PKH2 SERIES

## - MULTI-STEPS

### WIRING DIAGRAMS AND CODING

### MULTI-STEPS PKT2, PKS2, PKH2

Ordering code PKT2- **40T107**OF \_\_00  
PKS2- **40T107**OF \_\_00

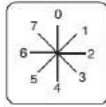

Multi-step PKT2- PKS2- PKH2-	40T107OF	__	__	00
<b>Rated current:</b>				
6 A	A			
10 A	PKT2	B		
16 A	C			
25 A	D			
32 A	E			
40 A	PKS2	F		
63 A	G			
<b>Front plate colour:</b>				
silver background and black knob		A		
yellow background and red knob		Y		
<b>Acceptance tests:</b>				
without additional quality requirements				0
with an extra quality inspection certificate				1

Description	PKT2			PKS2			
	6A	10A	16A	25A	32A	40A	63A
	Stage number						
1-polar 7-way + OFF	4	4	4	4	4	4	4

OUTPUT SIDE	1A	2A	3A	4A	5A	6A	7A
30°							
INPUT SIDE	LA	LA	LA	LA	LA	LA	LA
0							
1	X						
2		X					
3			X				
4				X			
5					X		
6						X	
7							X

Ordering code PKT2- **30L108**OF \_\_00



Multi-step PKT2-	30L108OF	__	__	00
<b>Rated current:</b>				
6 A	A			
10 A	PKT2	B		
16 A	C			
<b>Front plate colour:</b>				
silver background and black knob		A		
yellow background and red knob		Y		
<b>Acceptance tests:</b>				
without additional quality requirements				0
with an extra quality inspection certificate				1

Description	PKT2		
	6A	10A	16A
	Stage number		
1-polar 8-way + OFF	4	4	4

OUTPUT SIDE	1A	2A	3A	4A	5A	6A	7A	8A
30°								
INPUT SIDE	LA	LA	LA	LA	LA	LA	LA	LA
0								
1	X							
2		X						
3			X					
4				X				
5					X			
6						X		
7							X	
8								X

# PKT2, PKS2, PKH2 SERIES

## - MULTI-STEPS

### WIRING DIAGRAMS AND CODING

### MULTI-STEPS PKT2, PKS2, PKH2

Ordering code PKT2-30T109OF-00



Multi-step PKT2-		30T109OF	-	-	00
<b>Rated current:</b>					
6 A		A			
10 A	PKT2	B			
16 A		C			
<b>Front plate colour:</b>					
silver background and black knob			A		
yellow background and red knob			Y		
<b>Acceptance tests:</b>					
without additional quality requirements				0	
with an extra quality inspection certificate				1	

Description	PKT2		
	6A	10A	16A
	Stage number		
1-polar 9-way + OFF	5	5	5

OUTPUT SIDE	1A	2A	3A	4A	5A	6A	7A	8A	9A
INPUT SIDE	LA	LA	LA	LA	LA	LA	LA	LA	LA
0									
1	X								
2		X							
3			X						
4				X					
5					X				
6						X			
7							X		
8								X	
9									X

Ordering code PKT2-30T110OF-00



Multi-step PKT2-		30T110OF	-	-	00
<b>Rated current:</b>					
6 A		A			
10 A	PKT2	B			
16 A		C			
<b>Front plate colour:</b>					
silver background and black knob			A		
yellow background and red knob			Y		
<b>Acceptance tests:</b>					
without additional quality requirements				0	
with an extra quality inspection certificate				1	

Description	PKT2		
	6A	10A	16A
	Stage number		
1-polar 10-way + OFF	5	5	5

OUTPUT SIDE	1A	2A	3A	4A	5A	6A	7A	8A	9A	10A
INPUT SIDE	LA	LA	LA	LA	LA	LA	LA	LA	LA	LA
0										
1	X									
2		X								
3			X							
4				X						
5					X					
6						X				
7							X			
8								X		
9									X	
10										X

Ordering code PKT2-30T111OF-00

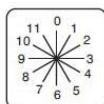

Multi-step PKT2-		30T111OF	-	-	00
<b>Rated current:</b>					
6 A		A			
10 A		B			
16 A		C			
<b>Front plate colour:</b>					
silver background and black knob			A		
yellow background and red knob			Y		
<b>Acceptance tests:</b>					
without additional quality requirements				0	
with an extra quality inspection certificate				1	

Description	PKT2		
	6A	10A	16A
	Stage number		
1-polar 11-way + OFF	6	6	6

OUTPUT SIDE	1A	2A	3A	4A	5A	6A	7A	8A	9A	10A	11A
INPUT SIDE	LA	LA	LA	LA	LA	LA	LA	LA	LA	LA	LA
0											
1	X										
2		X									
3			X								
4				X							
5					X						
6						X					
7							X				
8								X			
9									X		
10										X	
11											X

# PKT2, PKS2, PKH2 SERIES

## - MULTI-STEPS

### WIRING DIAGRAMS AND CODING

### MULTI-STEPS PKT2, PKS2, PKH2

Ordering code PKT2- 60L\_03WF\_00  
 PKS2- 60L\_03WF\_00  
 PKH2- 60L\_03WF\_00

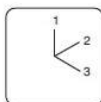

Multi-step PKT2- PKS2- PKH2-		60L	03WF	00
<b>Rated current:</b>				
6 A		A		
10 A	PKT2	B		
16 A		C		
25 A		D		
32 A		E		
40 A	PKS2	F		
63 A		G		
100 A		H		
200 A	PKH2	I		
<b>Pole:</b>				
1 pole			1	
2 poles			2	
3 poles			3	
4 poles			4	
<b>Front plate colour:</b>				
silver background and black knob			A	
yellow background and red knob			Y	
<b>Acceptance tests:</b>				
without additional quality requirements				0
with an extra quality inspection certificate				1

Ordering code PKT2- 90T\_04WF\_00  
 PKS2- 90T\_04WF\_00  
 PKH2- 90T\_04WF\_00



Multi-step PKT2- PKS2- PKH2-		90T	04WF	00
<b>Rated current:</b>				
6 A		A		
10 A	PKT2	B		
16 A		C		
25 A		D		
32 A		E		
40 A	PKS2	F		
63 A		G		
100 A		H		
200 A	PKH2	I		
<b>Pole:</b>				
1 pole			1	
2 poles			2	
3 poles			3	
<b>Front plate colour:</b>				
silver background and black knob			A	
yellow background and red knob			Y	
<b>Acceptance tests:</b>				
without additional quality requirements				0
with an extra quality inspection certificate				1

Description	PKT2			PKS2				PKH2	
	6A	10A	16A	25A	32A	40A	63A	100A	200A
	Stage number								
1-polar 3-way without OFF	2	2	2	2	2	2	2	2	2
2-polar 3-way without OFF	3	3	3	3	3	3	3	3	3
3-polar 3-way without OFF	5	5	5	5	5	5	5	5	5
4-polar 3-way without OFF	6	6	6	6	6	6	6	6	6

Description	PKT2			PKS2				PKH2	
	6A	10A	16A	25A	32A	40A	63A	100A	200A
	Stage number								
1-polar 4-way without OFF	2	2	2	2	2	2	2	2	2
2-polar 4-way without OFF	4	4	4	4	4	4	4	4	4
3-polar 4-way without OFF	6	6	6	6	6	6	6	6	6

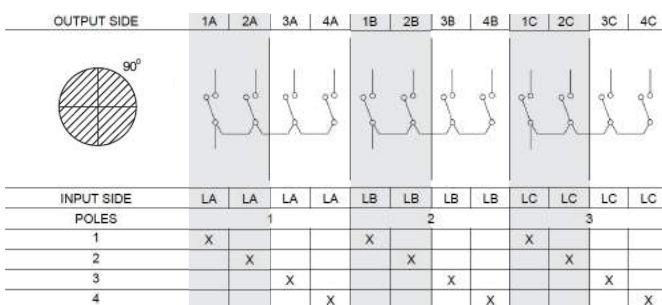
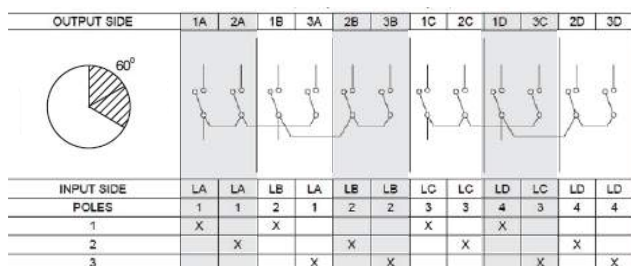

# PKT2, PKS2, PKH2 SERIES

## - MULTI-STEPS

### WIRING DIAGRAMS AND CODING

### MULTI-STEPS PKT2, PKS2, PKH2

Ordering code PKT2- 60L\_05WF \_00  
PKS2- 60L\_05WF \_00  
PKH2- 60L\_05WF \_00



Multi-step PKT2- PKS2- PKH2-		60L	05WF		00
<b>Rated current:</b>					
6 A		A			
10 A	PKT2	B			
16 A		C			
25 A		D			
32 A	PKS2	E			
40 A		F			
63 A		G			
100 A	PKH2	H			
200 A		I			
<b>Pole:</b>					
1 pole			1		
2 poles			2		
<b>Front plate colour:</b>					
silver background and black knob					A
yellow background and red knob					Y
<b>Acceptance tests:</b>					
without additional quality requirements					0
with an extra quality inspection certificate					1

Ordering code PKT2- 60T\_06WF \_00  
PKS2- 60T\_06WF \_00  
PKH2- 60T\_06WF \_00

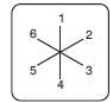

Multi-step PKT2- PKS2- PKH2-		60t	06WF		00
<b>Rated current:</b>					
6 A		A			
10 A	PKT2	B			
16 A		C			
25 A		D			
32 A	PKS2	E			
40 A		F			
63 A		G			
100 A	PKH2	H			
200 A		I			
<b>Pole:</b>					
1 pole			1		
2 poles			2		
<b>Front plate colour:</b>					
silver background and black knob					A
yellow background and red knob					Y
<b>Acceptance tests:</b>					
without additional quality requirements					0
with an extra quality inspection certificate					1

Description	PKT2			PKS2				PKH2	
	6A	10A	16A	25A	32A	40A	63A	100A	200A
	Stage number								
1-polar 5-way without OFF	3	3	3	3	3	3	3	3	3
2-polar 5-way without OFF	5	5	5	5	5	5	5	5	5

Description	PKT2			PKS2				PKH2	
	6A	10A	16A	25A	32A	40A	63A	100A	200A
	Stage number								
1-polar 6-way without OFF	3	3	3	3	3	3	3	3	3
2-polar 6-way without OFF	6	6	6	6	6	6	6	6	6

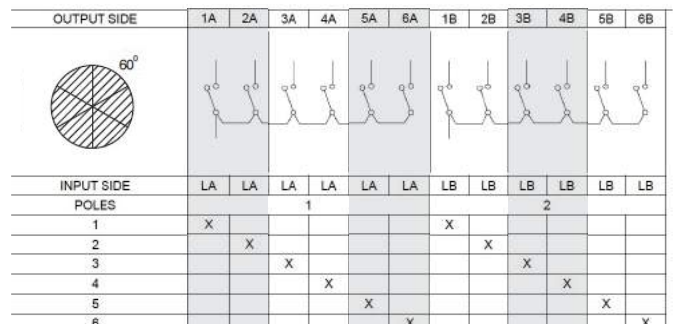
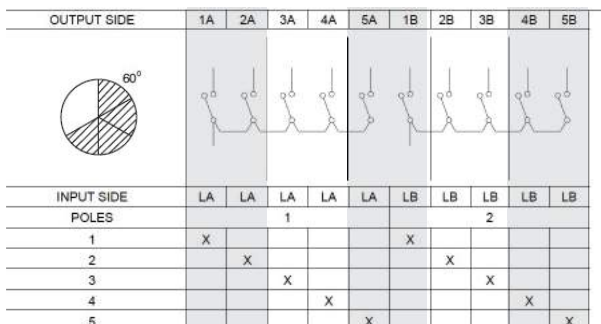

# PKT2, PKS2, PKH2 SERIES

## - MULTI-STEPS

### WIRING DIAGRAMS AND CODING

### MULTI-STEPS PKT2, PKS2, PKH2

Ordering code PKT2- 40L107WF \_\_00  
PKS2- 40L107WF \_\_00

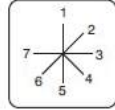

Multi-step PKT2- PKS2-		40L107WF	-	-	00
<b>Rated current:</b>					
6 A		A			
10 A	PKT2	B			
16 A		C			
25 A		D			
32 A		E			
40 A	PKS2	F			
63 A		G			
<b>Front plate colour:</b>					
silver background and black knob			A		
yellow background and red knob			Y		
<b>Acceptance tests:</b>					
without additional quality requirements				0	
with an extra quality inspection certificate				1	

Ordering code PKT2- 40T108WF \_\_00  
PKS2- 40T108WF \_\_00

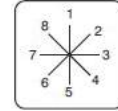

Multi-step PKT2- PKS2-		40T108WF	-	-	00
<b>Rated current:</b>					
6 A		A			
10 A	PKT2	B			
16 A		C			
25 A		D			
32 A		E			
40 A	PKS2	F			
63 A		G			
<b>Front plate colour:</b>					
silver background and black knob			A		
yellow background and red knob			Y		
<b>Acceptance tests:</b>					
without additional quality requirements				0	
with an extra quality inspection certificate				1	

Description	PKT2			PKS2			
	6A	10A	16A	25A	32A	40A	63A
	Stage number						
1-polar 7-way without OFF	4	4	4	4	4	4	4

Description	PKT2			PKS2			
	6A	10A	16A	25A	32A	40A	63A
	Stage number						
1-polar 8-way without OFF	4	4	4	4	4	4	4

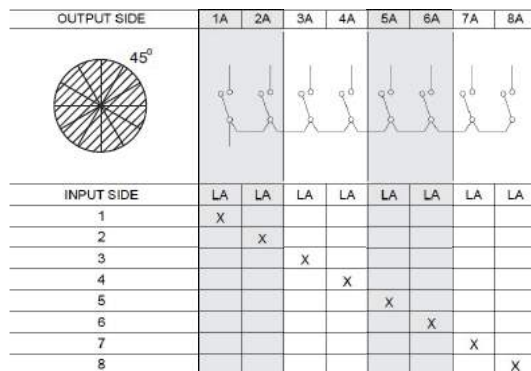
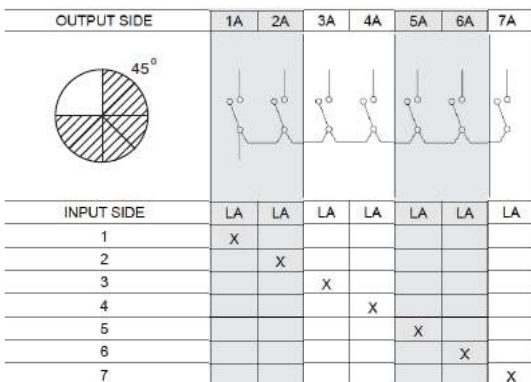

# PKT2, PKS2, PKH2 SERIES

## - MULTI-STEPS

### WIRING DIAGRAMS AND CODING

### MULTI-STEPS PKT2, PKS2, PKH2

Ordering code PKT2-30L109WF-00

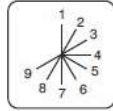

Multi-step PKT2-		30L109WF	-	-	00
<b>Rated current:</b>					
6 A		A			
10 A	PKT2	B			
16 A		C			
<b>Front plate colour:</b>					
silver background and black knob		A			
yellow background and red knob		Y			
<b>Acceptance tests:</b>					
without additional quality requirements					0
with an extra quality inspection certificate					1

Description	PKT2		
	6A	10A	16A
	Stage number		
1-polar 9-way without OFF	5	5	5

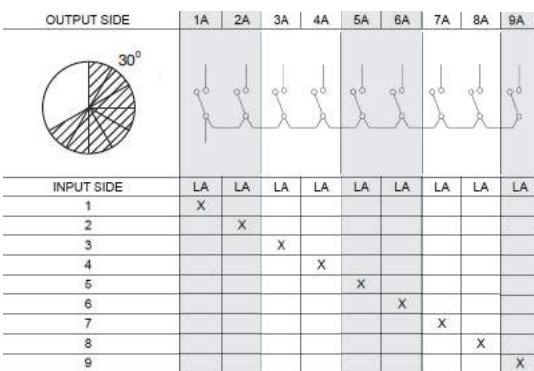

Ordering code PKT2-30L110WF-00



Multi-step PKT2-		30L110WF	-	-	00
<b>Rated current:</b>					
6 A		A			
10 A	PKT2	B			
16 A		C			
<b>Front plate colour:</b>					
silver background and black knob		A			
yellow background and red knob		Y			
<b>Acceptance tests:</b>					
without additional quality requirements					0
with an extra quality inspection certificate					1

Description	PKT2		
	6A	10A	16A
	Stage number		
1-polar 10-way without OFF	5	5	5

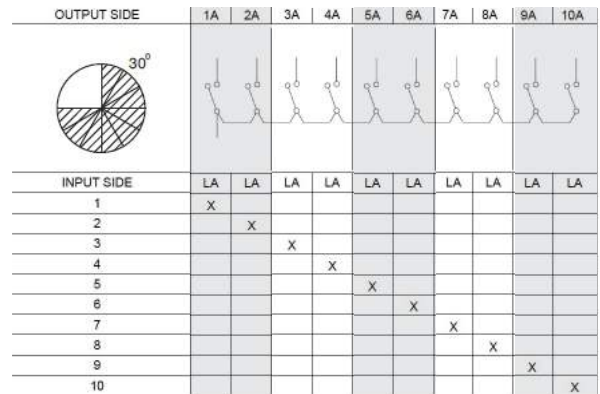

Ordering code PKT2-30L111WF-00



Multi-step PKT2-		30L111WF	-	-	00
<b>Rated current:</b>					
6 A		A			
10 A		B			
16 A		C			
<b>Front plate colour:</b>					
silver background and black knob		A			
yellow background and red knob		Y			
<b>Acceptance tests:</b>					
without additional quality requirements					0
with an extra quality inspection certificate					1

Description	PKT2		
	6A	10A	16A
	Stage number		
1-polar 11-way without OFF	6	6	6

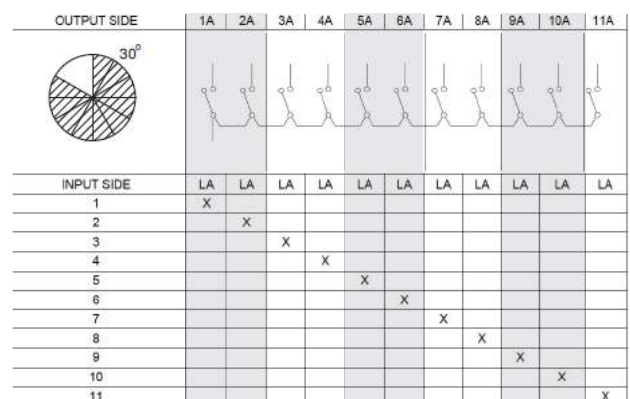

# PKT2, PKS2, PKH2 SERIES

## - MULTI-STEPS

### WIRING DIAGRAMS AND CODING

### MULTI-STEPS PKT2, PKS2, PKH2

Ordering code PKT2-30T112WF\_\_00



Multi-step PKT2-		30T112WF	-	-	00
<b>Rated current:</b>					
6 A	A				
10 A	PKT2	B			
16 A	C				
<b>Front plate colour:</b>					
silver background and black knob		A			
yellow background and red knob		Y			
<b>Acceptance tests:</b>					
without additional quality requirements				0	
with an extra quality inspection certificate				1	

Description	PKT2		
	6A	10A	16A
	Stage number		
1-polar 12-way without OFF	6	6	6

OUTPUT SIDE	1A	2A	3A	4A	5A	6A	7A	8A	9A	10A	11A	12A
INPUT SIDE	LA	LA	LA	LA	LA	LA	LA	LA	LA	LA	LA	LA
1	X											
2		X										
3			X									
4				X								
5					X							
6						X						
7							X					
8								X				
9									X			
10										X		
11											X	
12												X

### CODING OF PKT2, PKS2, PKH2 SERIES

Multi-step PKT2- PKS2- PKH2-	-	-	0	-	-	-	-	F	-	-	00
<b>Rated current:</b>											
6 A	A										
10 A	PKT2	B									
16 A	C										
25 A	D										
32 A	PKS2	E									
40 A	F										
63 A	G										
100 A	H										
200 A	PKH2	I									
<b>Angle:</b>											
30°	3										
45°	4										
60°	6										
90°	9										
----- 0											
<b>Rotation angle:</b>											
360°								T			
less than 360°								L			
<b>Pole:</b>											
1 pole											1
2 poles											2
3 poles											3
4 poles											4
<b>No. of ways:</b>											
3 ways											03
4 ways											04
....											...
12 ways											12
<b>OFF way:</b>											
without OFF											W
with OFF											O
----- F											
<b>Front plate colour:</b>											
silver background and black knob		A									
yellow background and red knob		Y									
<b>Acceptance tests:</b>											
without additional quality requirements				0							
with an extra quality inspection certificate				1							
<b>Version:</b>											
standard											00
custom-made*											XX

\* - only after agreeing with the manufacturer

# PKT3, PKS3, PKH3 SERIES

## - ISOLATORS

### WIRING DIAGRAMS AND CODING

### ISOLATORS PKT3, PKS3, PKH3

Ordering code PKT3- 60L\_XXOF\_00  
PKS3- 60L\_XXOF\_00  
PKH3- 60L\_XXOF\_00

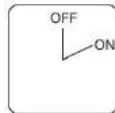

Isolator PKT3- PKS3- PKH3-		60L	XXOF			00
<b>Rated current:</b>						
6 A		A				
10 A	PKT3	B				
16 A		C				
25 A		D				
32 A		E				
40 A	PKS3	F				
63 A		G				
100 A		H				
200 A	PKH3	I				
<b>Pole:</b>						
1 pole			1			
2 poles			2			
....			...			
9 poles			9			
10 poles			A			
11 poles			B			
12 poles			C			
<b>Front plate colour:</b>						
silver background and black knob						A
yellow background and red knob						Y
<b>Acceptance tests:</b>						
without additional quality requirements						0
with an extra quality inspection certificate						1

Ordering code PKT3- 90L\_XXOF\_00  
PKS3- 90L\_XXOF\_00  
PKH3- 90L\_XXOF\_00

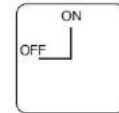

Isolator PKT3- PKS3- PKH3-		90L	XXOF			00
<b>Rated current:</b>						
6 A		A				
10 A	PKT3	B				
16 A		C				
25 A		D				
32 A		E				
40 A	PKS3	F				
63 A		G				
100 A		H				
200 A	PKH3	I				
<b>Pole:</b>						
1 pole			1			
2 poles			2			
....			...			
9 poles			9			
10 poles			A			
11 poles			B			
12 poles			C			
<b>Front plate colour:</b>						
silver background and black knob						A
yellow background and red knob						Y
<b>Acceptance tests:</b>						
without additional quality requirements						0
with an extra quality inspection certificate						1

#### ITEMS AVAILABLE FROM OUR STOCK:

##### PKT3-C60L3XXOFA000

- Isolator 16A, angle 60°, rotation angle <360°, 3 poles, with OFF, rectangular knob, silver background, black knob

##### PKT3-C60L3XXOFY000

- Isolator 16A, angle 60°, rotation angle <360°, 3 poles, with OFF, rectangular knob, yellow background, red knob

Description	PKT3			PKS3				PKH3	
	6A	10A	16A	25A	32A	40A	63A	100A	200A
	Stage number								
1-polar ON-OFF	1	1	1	1	1	1	1	1	1
2-polar ON-OFF	1	1	1	1	1	1	1	1	1
3-polar ON-OFF	2	2	2	2	2	2	2	2	2
4-polar ON-OFF	2	2	2	2	2	2	2	2	2
5-polar ON-OFF	3	3	3	3	3	3	3	3	3
6-polar ON-OFF	3	3	3	3	3	3	3	3	3

Description	PKT3			PKS3				PKH3	
	6A	10A	16A	25A	32A	40A	63A	100A	200A
	Stage number								
1-polar ON-OFF	1	1	1	1	1	1	1	1	1
2-polar ON-OFF	1	1	1	1	1	1	1	1	1
3-polar ON-OFF	2	2	2	2	2	2	2	2	2
4-polar ON-OFF	2	2	2	2	2	2	2	2	2
5-polar ON-OFF	3	3	3	3	3	3	3	3	3
6-polar ON-OFF	3	3	3	3	3	3	3	3	3

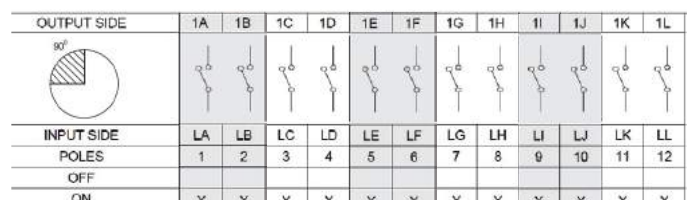
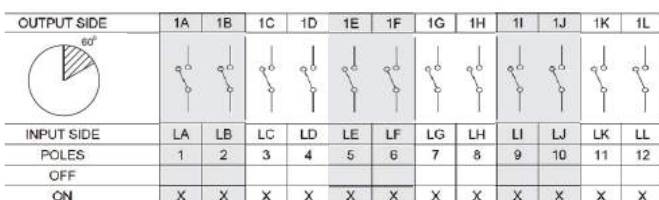



# PKT3, PKS3, PKH3 SERIES

## - ISOLATORS

### WIRING DIAGRAMS AND CODING

### ISOLATORS PKT3, PKS3, PKH3

Ordering code PKT3- 90T XXOF \_ 00  
 PKS3- 90T XXOF \_ 00  
 PKH3- 90T XXOF \_ 00

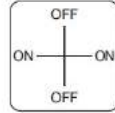

Isolator PKT3- PKS3- PKH3-		90T	XXOF			00
<b>Rated current:</b>						
6 A		A				
10 A	PKT3	B				
16 A		C				
25 A		D				
32 A		E				
40 A	PKS3	F				
63 A		G				
100 A		H				
200 A	PKH3	I				
<b>Pole:</b>						
1 pole			1			
2 poles			2			
....			...			
9 poles			9			
10 poles			A			
11 poles			B			
12 poles			C			
<b>Front plate colour:</b>						
silver background and black knob					A	
yellow background and red knob					Y	
<b>Acceptance tests:</b>						
without additional quality requirements						0
with an extra quality inspection certificate						1

Ordering code PKT3- 40L XXOF \_ 00  
 PKS3- 40L XXOF \_ 00

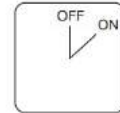

Isolator PKT3- PKS3-		40L	XXOF			00
<b>Rated current:</b>						
6 A		A				
10 A	PKT3	B				
16 A		C				
25 A		D				
32 A		E				
40 A	PKS3	F				
63 A		G				
<b>Pole:</b>						
1 pole						1
2 poles						2
....						...
9 poles						9
10 poles						A
11 poles						B
12 poles						C
<b>Front plate colour:</b>						
silver background and black knob					A	
yellow background and red knob					Y	
<b>Acceptance tests:</b>						
without additional quality requirements						0
with an extra quality inspection certificate						1

Description	PKT3			PKS3				PKH3	
	6A	10A	16A	25A	32A	40A	63A	100A	200A
	Stage number								
1-polar ON-OFF	1	1	1	1	1	1	1	1	1
2-polar ON-OFF	1	1	1	1	1	1	1	1	1
3-polar ON-OFF	2	2	2	2	2	2	2	2	2
4-polar ON-OFF	2	2	2	2	2	2	2	2	2
5-polar ON-OFF	3	3	3	3	3	3	3	3	3
6-polar ON-OFF	3	3	3	3	3	3	3	3	3

Description	PKT3			PKS3			
	6A	10A	16A	25A	32A	40A	63A
	Stage number						
1-polar ON-OFF	1	1	1	1	1	1	1
2-polar ON-OFF	1	1	1	1	1	1	1
3-polar ON-OFF	2	2	2	2	2	2	2
4-polar ON-OFF	2	2	2	2	2	2	2
5-polar ON-OFF	3	3	3	3	3	3	3
6-polar ON-OFF	3	3	3	3	3	3	3

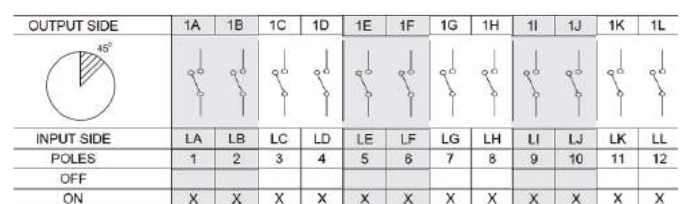
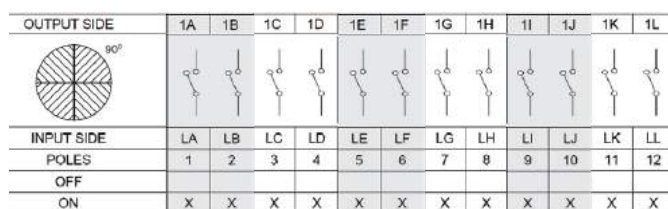

# PKT3, PKS3, PKH3 SERIES

## - ISOLATORS

### WIRING DIAGRAMS AND CODING

### ISOLATORS PKT3, PKS3, PKH3

#### CODING OF PKT3, PKS3, PKH3 SERIES

Isolator PKT3- PKS3- PKH3-		-	-	0	-	-	XX	O	F	-	-	00
<b>Rated current:</b>												
6 A		A										
10 A	PKT3	B										
16 A		C										
25 A		D										
32 A	PKS3	E										
40 A		F										
63 A		G										
100 A	PKH3	H										
200 A		I										
<b>Angle:</b>												
45°			4									
60°			6									
90°			9									
----- 0												
<b>Rotation angle:</b>												
360° *						T						
less than 360°						L						
<b>Pole:</b>												
1 pole						1						
2 poles						2						
....						...						
9 poles						9						
10 poles						A						
11 poles						B						
12 poles						C						
----- XX												
----- O												
----- F												
<b>Front plate colour:</b>												
silver background and black knob									A			
yellow background and red knob									Y			
<b>Acceptance tests:</b>												
without additional quality requirements											0	
with an extra quality inspection certificate											1	
<b>Version:</b>												
standard												00
custom-made**												XX

\* - only for rotation angle 90°

\*\* - only after agreeing with the manufacturer

### WIRING DIAGRAMS AND CODING

### SELECTOR SWITCHES PKT4

Ordering code PKT4- **69L**XXXOF \_ \_ 00

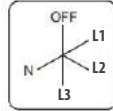

Selector switch PKT4-	69LXXXOF			00
<b>Rated current:</b>				
6 A	A			
10 A	B			
16 A	C			
20 A	D			
<b>Front plate colour:</b>				
silver background and black knob	A			
yellow background and red knob	Y			
<b>Acceptance tests:</b>				
without additional quality requirements			0	
with an extra quality inspection			1	

**ITEMS AVAILABLE FROM OUR STOCK:**

**PKT4-C69LXXXOFA000**

- Selector switch 16A, do amperomierza, 5-way L123/N/OFF, rotation angle <360°, with OFF, rectangular knob, silver background, black knob

**PKT4-C69LXXXOFY000**

- Selector switch 16A, do amperomierza, 5-way L123/N/OFF, rotation angle <360°, with OFF, rectangular knob, yellow background, red knob

Description	PKT4		
	6A	10A	16A
	Stage number		
5-way for the ammeter	4	4	4

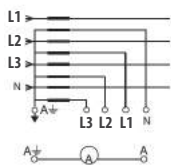
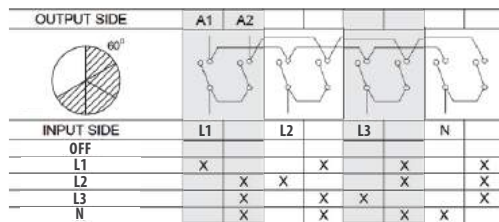

Ordering code PKT4- **97L**XXXOF \_ \_ 00

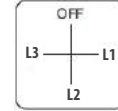

Selector switch PKT4-	97LXXXOF			00
<b>Rated current:</b>				
6 A	A			
10 A	B			
16 A	C			
20 A	D			
<b>Front plate colour:</b>				
silver background and black knob	A			
yellow background and red knob	Y			
<b>Acceptance tests:</b>				
without additional quality requirements			0	
with an extra quality inspection			1	

**ITEMS AVAILABLE FROM OUR STOCK:**

**PKT4-C97LXXXOFA000**

- Selector switch 16A, do amperomierza, 4-way L123/OFF, rotation angle 360°, with OFF, rectangular knob, silver background, black knob

**PKT4-C97LXXXOFY000**

- Selector switch 16A, do amperomierza, 4-way L123/OFF, rotation angle 360°, with OFF, rectangular knob, yellow background, red knob

Description	PKT4		
	6A	10A	16A
	Stage number		
4-way for the ammeter	3	3	3

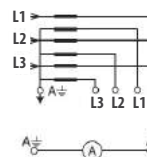
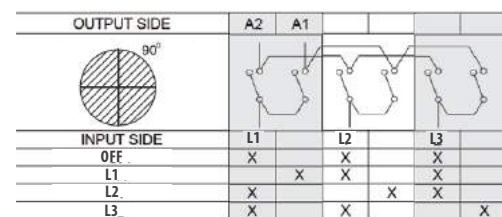

### WIRING DIAGRAMS AND CODING

### SELECTOR SWITCHES PKT4

Ordering code PKT4- **4HL**XXXOF\_\_00

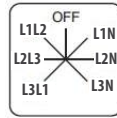

Selector switch PKT4-	4HLXXXOF	00
<b>Rated current:</b>		
6 A	A	
10 A	B	
16 A	C	
20 A	D	
<b>Front plate colour:</b>		
silver background and black knob	A	
yellow background and red knob	Y	
<b>Acceptance tests:</b>		
without additional quality requirements		0
with an extra quality inspection		1

**ITEMS AVAILABLE FROM OUR STOCK:**

**PKT4-C4HLXXXOFA000**

- Selector switch 16A, do woltomierza, 7-way L-L/L-N/OFF, rotation angle <math><360^\circ</math>, with OFF, rectangular knob, silver background, black knob

**PKT4-C4HLXXXOFY000**

- Selector switch 16A, do woltomierza, 7-way L-L/L-N/OFF, rotation angle <math><360^\circ</math>, with OFF, rectangular knob, yellow background, red knob

Description	PKT4		
	6A	10A	16A
	Stage number		
Phase and phase-to-phase voltages	3	3	3

OUTPUT SIDE		V2	V1			
INPUT SIDE		L3	L2	L1	N	
L3L1		X		X		
L2L2		X	X			
L1L2				X	X	
OFF						
L1N				X	X	
L2N			X		X	
L3N		X			X	

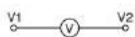
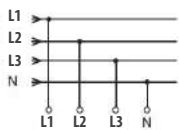

Ordering code PKT4- **9BT**XXXOF\_\_00

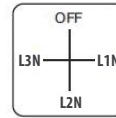

Selector switch PKT4-	9BTXXXOF	00
<b>Rated current:</b>		
6 A	A	
10 A	B	
16 A	C	
20 A	D	
<b>Front plate colour:</b>		
silver background and black knob	A	
yellow background and red knob	Y	
<b>Acceptance tests:</b>		
without additional quality requirements		0
with an extra quality inspection		1

Description	PKT4		
	6A	10A	16A
	Stage number		
Phase voltages	3	3	3

OUTPUT SIDE		V1	V2			
INPUT SIDE		N	L1	N	L2	N
OFF						
L1L2		X	X			
L2L3				X	X	
L3L1						X

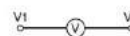
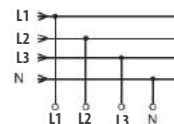

# PKT4 SERIES

## - SELECTOR SWITCHES

### WIRING DIAGRAMS AND CODING

### SELECTOR SWITCHES PKT4

Ordering code PKT4- 98TXXXOF \_ \_ 00

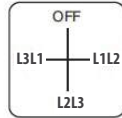

Selector switch PKT4-		98TXXXOF	-	-	00
<b>Rated current:</b>					
6 A	A				
10 A	B				
16 A	C				
20 A	D				
<b>Front plate colour:</b>					
silver background and black knob		A			
yellow background and red knob		Y			
<b>Acceptance tests:</b>					
without additional quality requirements		0			
with an extra quality inspection		1			

Description	PKT4		
	6A	10A	16A
	Stage number		
Phase-to-phase voltages	3	3	3

STRONA WYJŚCIOWA	V2	V1			
STRONA WEJŚCIOWA	L1	L2	L3		
OFF					
L1L2	X		X		
L2L3		X			X
L3L1		X		X	

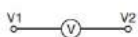
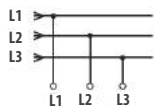

### CODING OF PKT4

Selector switch PKT4-	-	-	-	X	XX	O	F	-	-	00
<b>Rated current:</b>										
6 A	A									
10 A	B									
16 A	C									
20 A	D									
<b>Meter type:</b>										
ammeter L123/OFF/90°	97									
ammeter L123/N/OFF/60°	69									
voltmeter L-L/L-N/OFF/45°	4H									
voltmeter L-L/OFF/90°	98									
voltmeter L-N/OFF/90°	9B									
<b>Rotation angle:</b>										
360° *	T									
less than 360° **	L									
				X						
					XX					
						O				
							F			
<b>Front plate colour:</b>										
silver background and black knob		A								
yellow background and red knob		Y								
<b>Acceptance tests:</b>										
without additional quality requirements		0								
with an extra quality inspection certificate		1								
<b>Version:</b>										
standard		00								
custom-made***		XX								

\* - only for rotation angle 90°

\*\* - only for rotation angle 45° i 60°

\*\*\* - only after agreeing with the manufacturer

# PKT/ PKS/ PKH SERIES

## - CAM SWITCHES

### ACCESSORIES - ORDERING

Ordering code	Description	View	Cam switch type
20-042-06-00007	CAM SWITCH KNOB (Black)		PKT1, PKT2, PKT3, PKT4, PKS1, PKS2, PKS3, PKH1, PKH2, PKH3
20-042-06-00008	CAM SWITCH KNOB (Red)		PKT1, PKT2, PKT3, PKT4, PKS1, PKS2, PKS3, PKH1, PKH2, PKH3
20-042-06-00009	FRONT PLATE CAM SWITCH (Yellow)		PKT1, PKT2, PKT3, PKT4
20-042-06-00010	Yellow BLANK PAPER FOR MARKING PLATE		PKT1, PKT2, PKT3, PKT4
20-042-06-00011	Yellow BLANK PAPER FOR NAME PLATE		PKT1, PKT2, PKT3, PKT4
20-042-06-00012	BLANK NAME PLATE		PKT1, PKT2, PKT3, PKT4
20-042-06-00013	BLANK MARKING PLATE		PKT1, PKT2, PKT3, PKT4
20-042-06-00016	SCREWS AND NUTS		PKT1, PKT2, PKT3, PKT4

PKT-19\_en

